

Halbstabfräser

Half round cutter

Fraise demi-rond

Halbstabfräser

Half round cutter

Fraise demi-rond

SBC10-12



RL

Z2

HW

MAN
MEC

n.max
Tabelle
Table

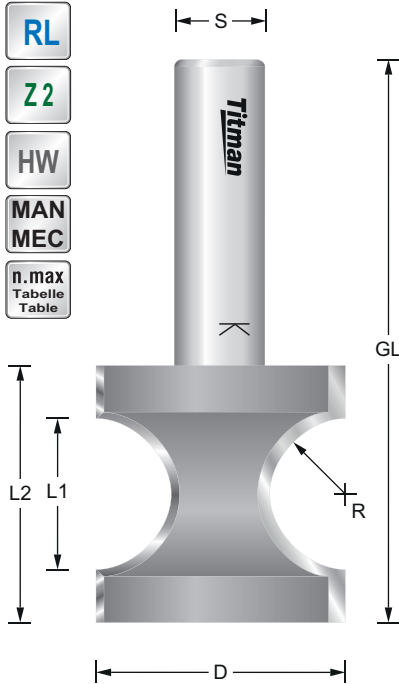

REF.	D mm	R mm	L1 mm	L2 mm	GL mm	S mm	EUR/1
SBC5-8	23	5	10	22	54	8	82,34 €
SBC5-10	23	5	10	22	54	10	82,34 €
SBC5-12	23	5	10	22	64	12	82,34 €
SBC6-8	25	6	12	25	57	8	84,59 €
SBC6-12	25	6	12	25	67	12	84,59 €
SBC7-8	27	7	14	28	60	8	89,22 €
SBC7-10	27	7	14	28	60	10	89,22 €
SBC7-12	27	7	14	28	70	12	89,22 €
SBC8-8	29	8	16	28	60	8	97,82 €
SBC8-12	29	8	16	28	70	12	97,82 €
SBC10-12	33	10	20	34	74	12	114,00 €
SBC12.7-10	45.5	12.7	25.4	42	74	10	117,94 €
SBC12.7-12	45.5	12.7	25.4	42	84	12	117,94 €
SBC14-12	48	14	28	44	86	12	131,60 €
SBC15-12	50	15	30	46	88	12	141,15 €
SBC16-12	52	16	32	48	90	12	143,97 €
SBC18-12	56	18	36	53	95	12	174,52 €

Ø Fräser/Cutter/Fraise	n.max
1 mm - 25 mm	24.000
26 mm - 50 mm	18.000
51 mm - 75 mm	16.000
76 mm - 100 mm	12.000

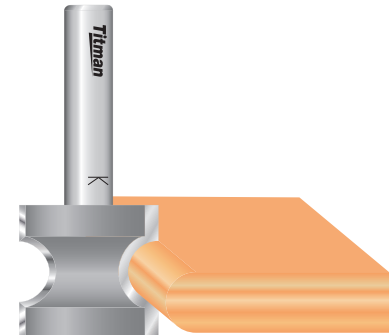

Halbstabfräser mit verlängerter Schneide

Half round profile cutter

Fraise demi-rond avec un tranchant allongé

WBC6-12



RL

Z2

HW

MAN
MEC

n.max
Tabelle
Table

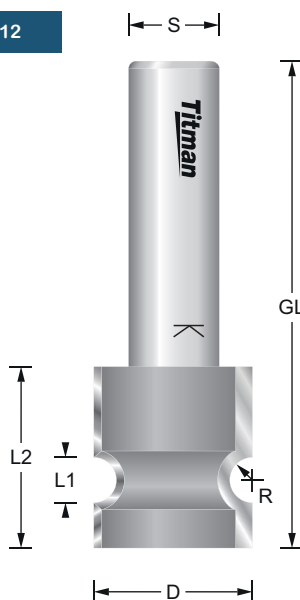

REF.	D mm	R mm	L1 mm	L2 mm	GL mm	S mm	EUR/1
WBC6-12	21	3	6	24	66	12	102,17 €
WBC8-12	23	4	8	26	68	12	109,78 €
WBC10-12	25	5	10	28	70	12	114,00 €



Ø Fräser/Cutter/Fraise	n.max
1 mm - 25 mm	24.000
26 mm - 50 mm	18.000
51 mm - 75 mm	16.000
76 mm - 100 mm	12.000