

Stab-/Eckleistenfräser mit Anlauflager

Staff and Corner profil cutter with bearing

Coupeur de profilé de personnel et d'angle avec roulement

CBC95-8



RL

Z2

HW

MAN
MEC

n.max
Tabelle
Table

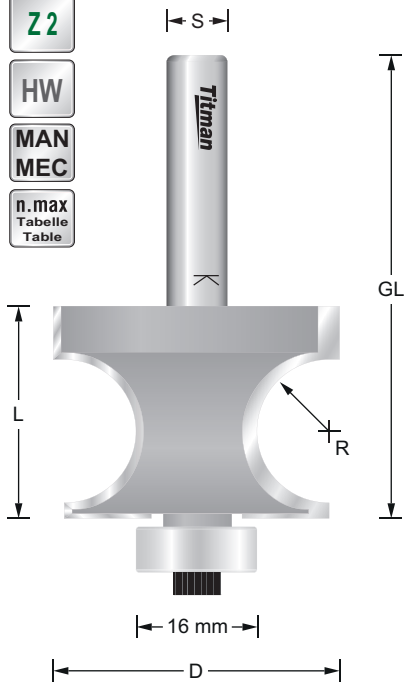

REF.	D mm	R mm	L mm	GL mm	S mm	EUR/1
CBC2-8	24	2	12	44	8	85,66 €
CBC32-8	26	3.2	13	45	8	89,45 €
CBC48-8	27	4.8	16	48	8	96,19 €
CBC63-8	32	6.3	23	55	8	104,47 €
CBC95-8	38	9.5	28	60	8	124,75 €

REF.	Ersatzteile - Spare parts - Pièces de rechange	EUR/1
B16	Anlauflager / Bearing / Roulement D=16 d=6,35	10,63 €
ISKM4	Schraube Lager / Screw bearing / Vis roulement	3,40 €

Ø Fräser/Cutter/Fraise	n.max
1 mm - 25 mm	24.000
26 mm - 50 mm	18.000
51 mm - 75 mm	16.000
76 mm - 100 mm	12.000

CBC2-8

CBC32-8

CBC48-8

CBC63-8

CBC95-8

Effekt mit einer Fräsung.

Effect with one cut.

Effet avec un fraisage.



Effekt mit zweiter Fräsung.

Effect with second cut.

Effet avec un deuxième fraisage.

