

Fasefräser für hohe Beanspruchung

Bevel cutter heavy duty

Fraise à chanfreiner robuste

CHC30-12

REF.	D mm	d mm	A°	L1 mm	L2 mm	GL mm	S mm	EUR/1
CHC30-12	60	12.7	30°	13.7	20	62	12	109,05 €
CHC45-12	41	12.7	45°	14	22	62	12	85,00 €
CHC45LK-12	58	12.7	45°	24	30	72	12	101,53 €
CHC60-12	38	12.7	60°	19	27	67	12	87,55 €

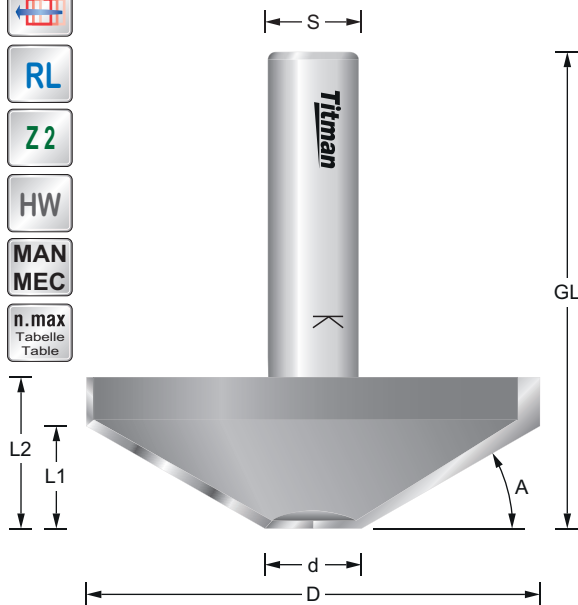

CHC45-12

CHC60-12

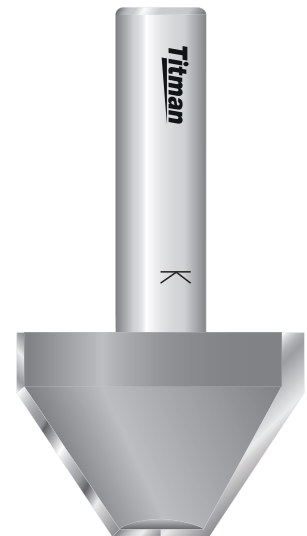

Fasefräser mit hoher Nutzlänge

Bevel cutter with high cutting length

Fraise à chanfreiner avec grande longueur de coupe

BC30-12

REF.	D mm	d mm	A°	L1 mm	L2 mm	GL mm	S mm	EUR/1
BC10-8	25	12.7	10°	35	-	67	8	92,32 €
BC10-12	25	12.7	10°	35	-	75	12	92,32 €
BC15-12	30	12.7	15°	35	-	75	12	100,91 €
BC20-12	38	12.7	20°	35	-	75	12	100,91 €
BC30-12	53	12.7	30°	35	44	85	12	163,95 €
BC45-16	82	12.7	45°	35	44	93	16	213,61 €

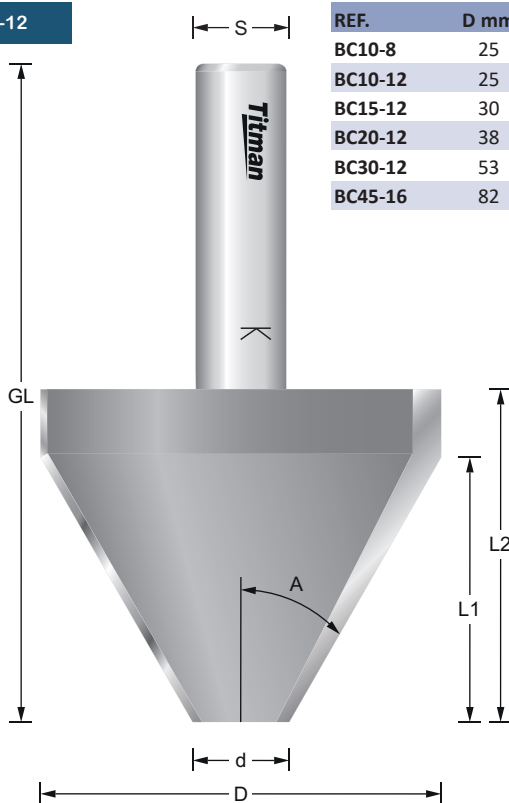

BC10-8

BC20-12

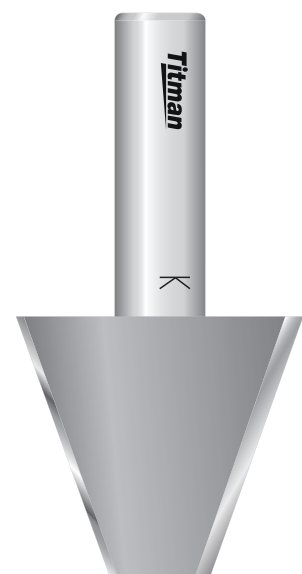

Ø Fräser/Cutter/Fraise	n.max
1 mm - 25 mm	24.000
26 mm - 50 mm	18.000
51 mm - 75 mm	16.000
76 mm - 100 mm	12.000