

# Fasefräser mit Anlauflager und hoher Nutzlänge

Bevel cutter with bearing and high cutting length

Fraise à chanfreiner avec roulement et grande longueur de coupe

BCB30-12



RL

Z2

HW

MAN  
MEC

n.max  
Tabelle  
Table

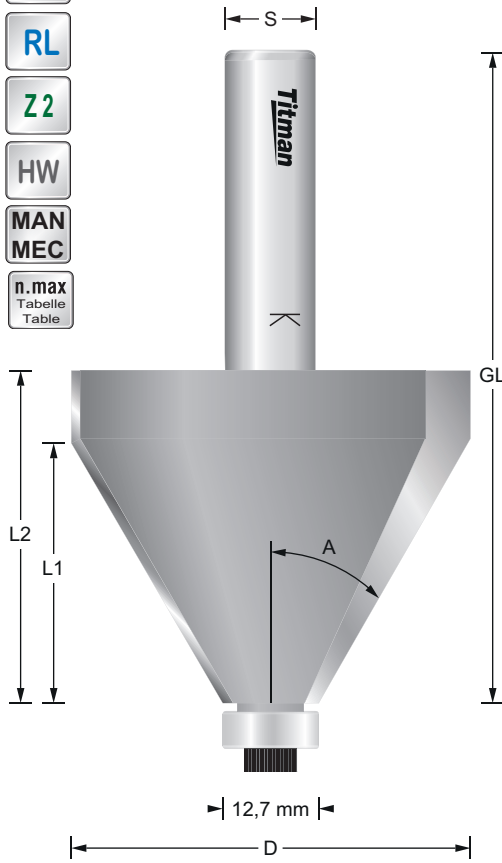

REF.	D mm	A°	L1 mm	L2 mm	GL mm	S mm	EUR/1
BCB10-8	26	10°	35	-	65	8	97,27 €
BCB10-12	26	10°	35	-	75	12	97,27 €
BCB15-12	30	15°	35	-	75	12	106,18 €
BCB20/S-8	33	20°	30	-	65	8	95,99 €
BCB20-12	35	20°	35	-	75	12	106,18 €
BCB22.5-12	41	22.5°	35	-	77	12	106,18 €
BCB30/S-8	36	30°	20	-	58	8	103,29 €
BCB30-12	53	30°	35	44	85	12	168,87 €

REF.	Ersatzteile - Spare parts - Pièces de rechange	EUR/1
B127	Anlauflager / Bearing / Roulement D=12,7 d=6,35	11,26 €
ISKM4	Schraube Lager / Screw bearing / Vis roulement	3,60 €

BCB10-8

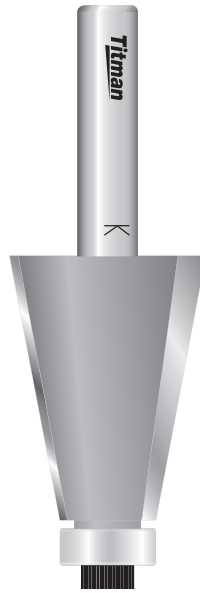

BCB20/S-8

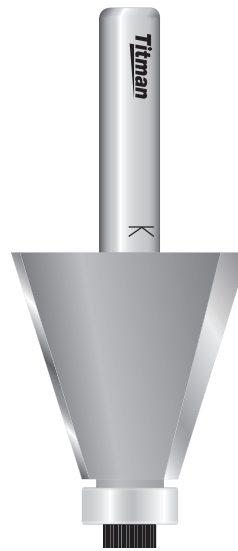

BCB30/S-8

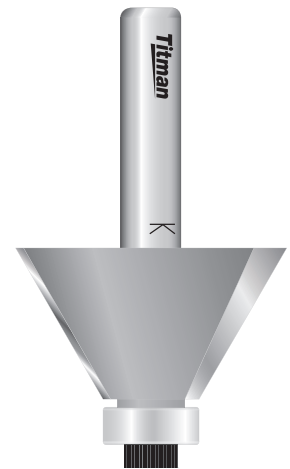

Ø Fräser/Cutter/Fraise	n.max
1 mm - 25 mm	24.000
26 mm - 50 mm	18.000
51 mm - 75 mm	16.000
76 mm - 100 mm	12.000

BCB10-12

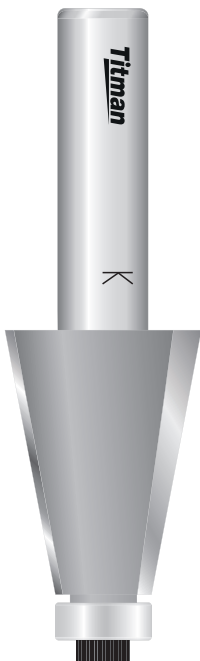

BCB15-12

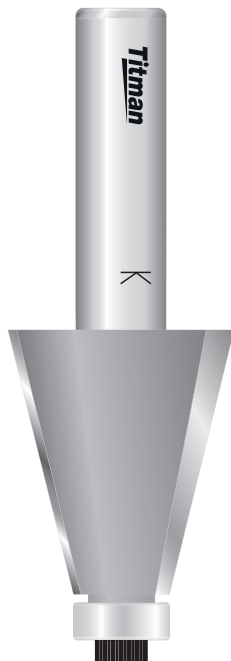

BCB20-12

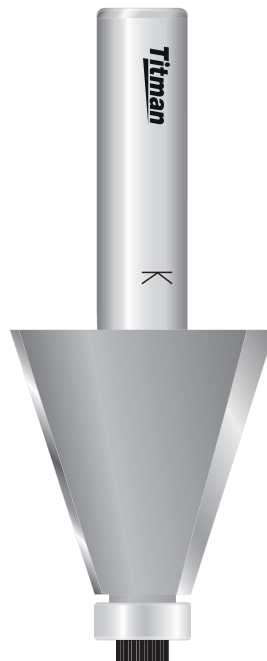

BCB22.5-12

