

Mini-Spannzangenfutter

Mini collet chucks

Mini mandrins à pince

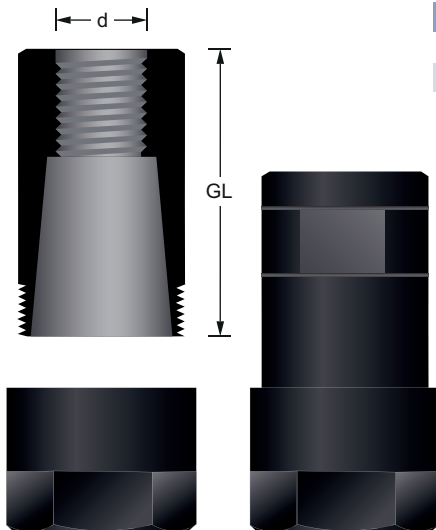

REF.	GL mm	d mm	EUR/1
SPZ-M10	38	M10x1,5	73,78 €
SPZ-M12	38	M12x1	73,78 €

Passende Spannzangen Typ 407E / OZ12

Suitable collets type 407E / OZ12

Pinces de serrage adaptées type 407E / OZ12

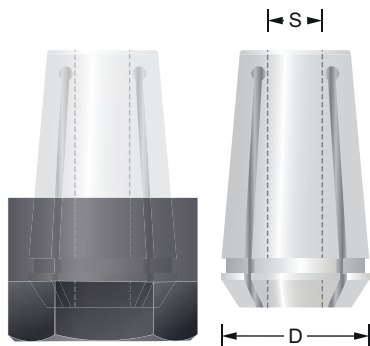

REF.	D mm	L mm	S mm	EUR/1
407E-3	19.5	34	3	36,27 €
407E-4	19.5	34	4	36,27 €
407E-5	19.5	34	5	36,27 €
407E-6	19.5	34	6	36,27 €
407E-7	19.5	34	7	36,27 €
407E-8	19.5	34	8	36,27 €
407E-9	19.5	34	9	36,27 €
407E-10	19.5	34	10	36,27 €
407E-11	19.5	34	11	36,27 €
407E-12	19.5	34	12	36,27 €