

# T-Nutfräser

T-Slot cutter

Fraises à profiler en T

TSS28-8

REF.	D mm	d mm	L1 mm	L2 mm	GL mm	S mm	EUR/1
TSS127-8	12.7	7	2.5	10	42	8	58,58 €
TSS15-8	15	8	6	14	46	8	70,36 €
TSS28-8	28	9.5	8	26	58	8	94,87 €
TSS28-12	28	9.5	8	26	68	12	94,87 €
TSS35-12	35	12.7	9.5	27.5	70	12	113,48 €

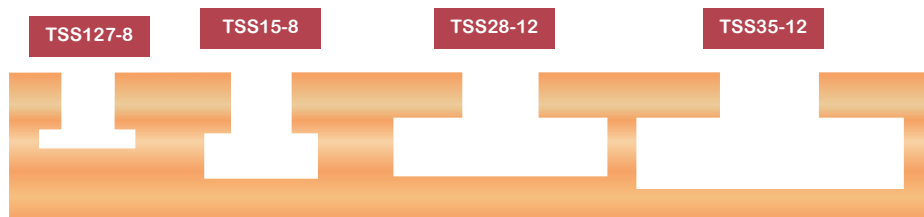
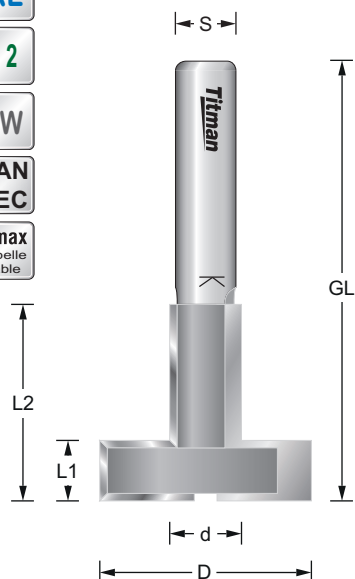

Ø Fräser/Cutter/Fraise	n.max
1 mm - 25 mm	24.000
26 mm - 50 mm	18.000
51 mm - 75 mm	16.000
76 mm - 100 mm	12.000

# T-Nutfräser mit Radius

T-Slot cutter with radius

Fraises à profiler en T avec rayon

TSR40-12

REF.	D mm	d mm	R mm	L1 mm	L2 mm	GL mm	S mm	EUR/1
TSR28-12	28	11.2	2	4	19	62	12	109,50 €
TSR40-12	40.8	9.7	2	4	19	62	12	113,48 €

